

U.S. RIFLE

7.62MM, M14 AND M14E2

CHAPTER 1. INTRODUCTION	Paragraph	Page
Purpose and scope.....	1	2
Importance of mechanical training.....	2	3
Description of the rifles.....	3	3
General data.....	4	4
2. MECHANICAL TRAINING		
General.....	5	6
Clearing the rifle.....	6	6
Disassembly into three main groups.....	7	7
Assembly of the three main groups.....	8	7
Disassembly of the barrel and receiver group.....	9	9
Assembly of the barrel and receiver group.....	10	10
Disassembly of the gas system and handguard.....	11	13
Replacing the stabilizer assembly of the M14E2 rifle.....	12	13
Removing the stabilizer assembly of the M14E2 rifle.....	13	14
Replacing the stabilizer assembly of the M14E2 rifle.....	14	14
Disassembly of the magazine.....	15	14
Assembly of the magazine.....	16	14
3. OPERATION AND FUNCTIONING		
Section I. Operation		
Loading the magazine (out of the rifle).....	17	19
Loading the magazine (in the rifle).....	18	19
Loading and unloading the rifle.....	19	19
Section II. Functioning		
Semiautomatic.....	20	19
Automatic (rifles equipped with selector).....	21	26
CHAPTER 4. STOPPAGES AND IMMEDIATE ACTION		
Stoppages.....	22	28
Immediate action.....	23	29
5. MAINTENANCE		
General.....	24	30
Cleaning materials, lubricants, and equipment.....	25	30
Cleaning the rifle.....	26	32
Normal maintenance.....	27	33
Special maintenance.....	28	39
6. AMMUNITION		
General.....	29	40
Description.....	30	40
Packaging.....	31	40
Care, handling, and preservation.....	32	40
7. ACCESSORIES		
M2 bipod.....	33	42
M6 bayonet knife and M8A1 bayonet knife scabbard.....	34	42
M76 grenade launcher.....	35	42
M15 grenade launcher site.....	36	42
M12 blank firing attachment and M3 breech shield.....	37	45
Winter trigger kit.....	38	48
APPENDIX. REFERENCES	--	49

CHAPTER 1

INTRODUCTION

1. Purpose and Scope

a. This manual is a guide for commanders and instructors in presenting instruction in the mechanical operation of the M14 and M14E2 rifles. It includes a detailed description of the rifle and its general characteristics; procedures for detailed disassembly and assembly; an explanation of functioning; a discussion of the types of stoppages and the immediate action applied to reduce them; a description of the ammunition; and instructions on

the care, cleaning, and handling of each weapon and its ammunition.

b. Marksmanship training is covered in FM 23-71 and FM 23-16.

c. The material contained herein is applicable without modification to both nuclear and nonnuclear warfare.

d. Users of this manual are encouraged to submit recommended changes or comments to improve the publication. Comments should be keyed to the specific page, paragraph, and line of the text

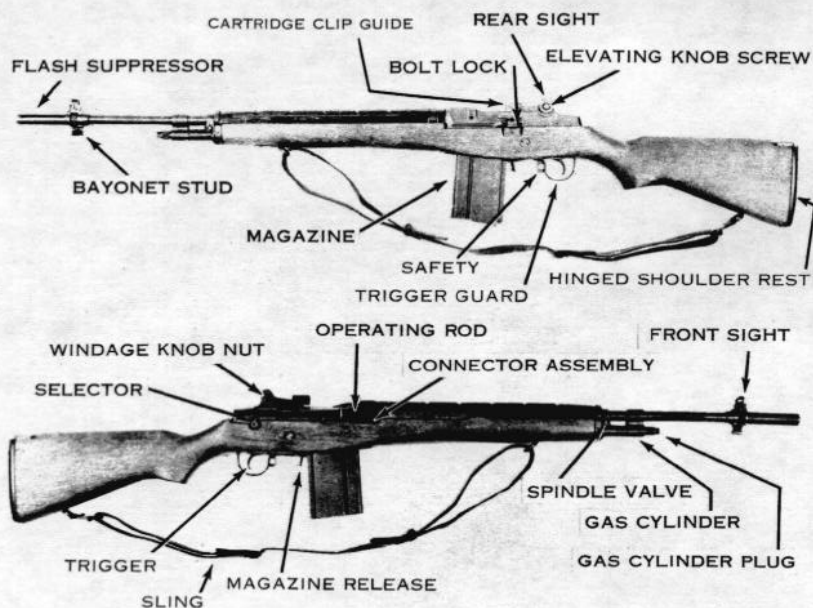

Figure 1. The M14 rifle.

in which the change is recommended. Reasons should be provided for each comment to insure understanding and complete evaluation. Comments should be forwarded direct to the Commandant, United States Army Infantry School, Fort Benning, Ga., 31905.

2. Importance of Mechanical Training

The rifle is the Infantryman's basic weapon. It gives him an individual and powerful capability for combat. To benefit the most from this capability, the Infantryman must develop two skills to an equal degree: he must be able to fire his weapon well enough to get hits on battlefield targets, and he must know enough about its working parts to keep it operating. The Infantryman attains his firing skill in marksmanship training. He learns how to keep his rifle in operable condition through mechanical training.

3. Description of the Rifles

a. M14 Rifle.

- (1) The U.S. rifle, 7.62mm, M14 (fig. 1) is a light-weight, air-cooled, gas-operated, magazine-fed, shoulder weapon. It is designed primarily for semiautomatic fire.
 - (2) When employed as an automatic rifle, the selector and bipod M2 must be installed (fig. 2).
 - (3) The flash suppressor is designed with a wide rib on the bottom to reduce muzzle climb and the amount of dust raised by muzzle blast.
- (4) The lug on the rear of the flash suppressor is used to secure a bayonet, a grenade launcher, and a blank firing attachment.
 - (5) The spindle valve is used when launching a grenade to prevent gas operation of the rifle, thus avoiding damage to the weapon.

b. M14E2 Rifle.

- (1) The U.S. rifle, 7.62mm, M14E2 (fig. 3) is an air-cooled, gas-operated, magazine-fed, shoulder weapon. It is capable of semiautomatic or automatic fire; however, it is designed primarily for automatic fire. It features a stabilizer assembly, modified bipod, front and rear handgrip, straight line stock, and a rubber recoil pad.
- (2) The M14E2 stock group is the "straight line" type with a fixed rear handgrip and a folding front handgrip which lies flat along the bottom of the stock when not in use. The location of the front handgrip can be adjusted to one of five positions in 1-inch increments to accommodate all gunners. The rubber recoil pad reduces the effects of recoil. The hinged shoulder rest provides vertical control of the butt end of the rifle. The butt swivel pivots 90° to the left for ease of carrying.
- (3) The stabilizer assembly consists of a perforated steel sleeve which slides over the flash suppressor and is fastened to the muzzle over the bayonet lug by a screw and a locknut. The stabilizer provides muzzle stability and reduces recoil.

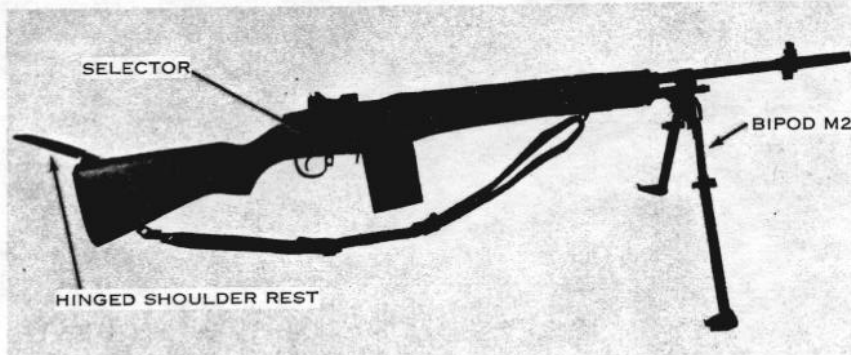

Figure 2. The M14 rifle with selector and M2 bipod.

- (4) The M2 bipod is modified by the addition of a sling swivel and a longer pivot pin to accommodate the swivel.
- (5) The M14E2 utilizes a sling with an extra hook assembly. The portion of the sling between the handgrip and the bipod provides additional muzzle control during firing. The portion of the sling between the front handgrip and the bipod allows

the average firer, by applying rearward pressure on the front handgrip, to increase the pressure of the bipod on the ground to approximately 35 pounds, reducing dispersion considerably. When the weapon is carried at sling arms, the sling must be disconnected from the handgrip assembly.

4. General Data

Weights in Pounds (approximate):

M14 rifle with full magazine and cleaning equipment.....	11¼
M14 rifle with full magazine, cleaning equipment, selector, and bipod.....	13
Empty magazine.....	½
Full magazine (with ball ammunition).....	1¾
Cleaning equipment.....	¾
M2 bipod.....	1¾
M14E2 rifle with full magazine.....	14¾

Lengths in Inches (approx.):

M14, overall, with flash suppressor.....	44¾
M14E2, overall, with stabilizer assembly.....	44¾
Sights:	
Front.....	fixed
Rear.....	adjustable (one click of elevation or windage moves the strike of the bullet .7 centimeter at 25 meters).



Figure 3. The M14E2 rifle (top—left side view; bottom—right side view).

<i>Trigger Pull in Pounds:</i>	
Minimum.....	5.5
Maximum.....	7.5
<i>Muzzle Velocity</i>	2,800 f.p.s. (853 m.p.s.).

Cyclic Rate of Fire (rounds per minute)..... 700-750

Rates of Fire. (These can be maintained without danger to the firer, or damage to the weapon):

<i>Semiautomatic</i> (rounds per minute):	
1 minute.....	40
2 minutes.....	40
5 minutes.....	30
10 minutes.....	20
15 minutes.....	20
20 minutes.....	20
30 minutes (or more).....	15

<i>Automatic</i> (rounds per minute):	
1 minute.....	60
2 minutes.....	50

*The bipod adds much stability to the rifle and enables the automatic rifleman to effectively engage targets semiautomatically in excess of 400 meters.

5 minutes.....	40
10 minutes.....	30
15 minutes.....	30
20 minutes.....	25
30 minutes (or more).....	20

Range in Meters:

Maximum effective (semiautomatic, without bipod).....	460
Maximum effective (semiautomatic, with bipod).....	*700
Maximum effective (automatic, with bipod).....	**460
Maximum.....	3725

Ammunition..... see chapter 6.

Definitions:

<i>Cyclic rate</i>	the rate at which the weapon fires automatically.
<i>Maximum effective range</i>	the greatest distance at which a weapon may be expected to fire accurately to inflict casualties or damage.

**Enemy squad formations and hasty crew-served weapons emplacements may be effectively engaged up to this range; bunker apertures, windows and like targets, which require precise accuracy, can best be engaged using semiautomatic fire.

CHAPTER 2

MECHANICAL TRAINING

5. General

a. The individual soldier is authorized to disassemble his rifle to the extent called field stripping. Chart I shows the parts he is permitted to disassemble with and without supervision. The amount of disassembly he is permitted to perform without supervision is adequate for normal maintenance.

b. *The frequency of disassembly and assembly should be kept to a minimum consistent with maintenance and instructional requirements.* Constant disassembly causes excessive wear of the parts and leads to their early unserviceability and to inaccuracy of the weapon.

c. The rifle has been designed to be taken apart and put together easily. No force is needed if it is disassembled and assembled correctly. The parts of one rifle, *except the bolt*, may be interchanged with those of another *when necessary*. *Bolts should never be interchanged for safety reasons.*

d. As the rifle is disassembled, the parts should be laid out from left to right, on a clean surface and in the order of removal. This makes assembly easier because the parts are assembled in the reverse order of disassembly. The names of the parts (nomenclature) should be taught along with disassembly and assembly to make further instruction on the rifle easier to understand.

6. Clearing the Rifle

The first step in handling any weapon is to clear it. To clear the rifle, first attempt to engage the safety. (If unable to place the safety in the safe position, continue with the second step of removing the magazine.) Remove the magazine by placing the right thumb on the magazine latch and

curl the remaining fingers around the front of the magazine. Press in on the magazine latch, rotate the base of the magazine toward the muzzle end of the rifle (fig. 4), and remove it from the magazine well. With the knife edge of the right hand, pull the operating rod handle all the way to the rear, reach across the receiver with the right thumb and press in on the bolt lock (fig. 5). Verify the

Chart I. Disassembly Authorization

Part	Individual soldier	Armorer	Maintenance personnel
SEPARATION INTO THREE MAIN GROUPS			
DISASSEMBLY:	X		
BARREL AND RECEIVER GROUP			
Front sight.....			X
Rear sight.....		X	
Flash suppressor.....			X
Spindle valve.....			X
Sear release.....		X	
Selector and selector shaft lock.....		X	
Bipod M2.....	X		
Connector assembly (spring and plunger).....			X
Bolt lock.....		X	
Cartridge clip guide.....			X
Operating rod guide.....			X
Barrel from receiver.....			X
Stabilizer assembly M14E2.....	X		
STOCK GROUP:			
Stock liner.....			X
Upper sling swivel bracket.....			X
Stock ferrule.....			X
MAGAZINE.....	X		
BOLT.....		X	
Bolt roller from bolt stud.....			X
FIRING MECHANISM			
Magazine latch.....		X	
Sear from trigger.....			X

safety, tilt the rifle, and look inside the chamber and receiver to insure that they contain no rounds.

7. Disassembly Into Three Main Groups

a. The three main groups are the firing mechanism, the barrel and receiver, and the stock.

b. After the rifle is cleared, the operating parts should be forward for disassembly. To do this, pull back on the operating rod handle and allow the bolt to go forward.

c. To remove the firing mechanism, grasp the rear of the trigger guard with the thumb and forefinger of your right hand and pull downward and outward until the mechanism is released (fig. 6). Lift out the firing mechanism.

d. To separate the barrel and receiver from the stock, lay the weapon on a flat surface with the sights up and muzzle to the left. Grasp the receiver with the left hand over the rear sight and raise the rifle a few inches. With the right hand, strike down on and grasp the small of the stock, separating the barrel and receiver from the stock. The three main groups are shown in figure 7.

e. The components of the M14E2 rifle are shown in figure 8.

8. Assembly of the Three Main Groups

a. Place the barrel and receiver group on a flat surface, sights down. Pick up the stock group and engage the stock ferrule in the front band, then lower the stock group onto the barrel and receiver group.

b. Open the trigger guard and place the firing mechanism straight down into the receiver, making sure that the guide rib on the firing mechanism enters the recess in the receiver (fig. 9). Place the butt of the weapon on the left thigh, sights to the left, insuring the trigger guard has cleared the trigger. With the palm of the right hand, strike the trigger guard fully engaging it to the receiver.



Figure 4. Removing the magazine.



Figure 5. Locking the bolt to the rear.

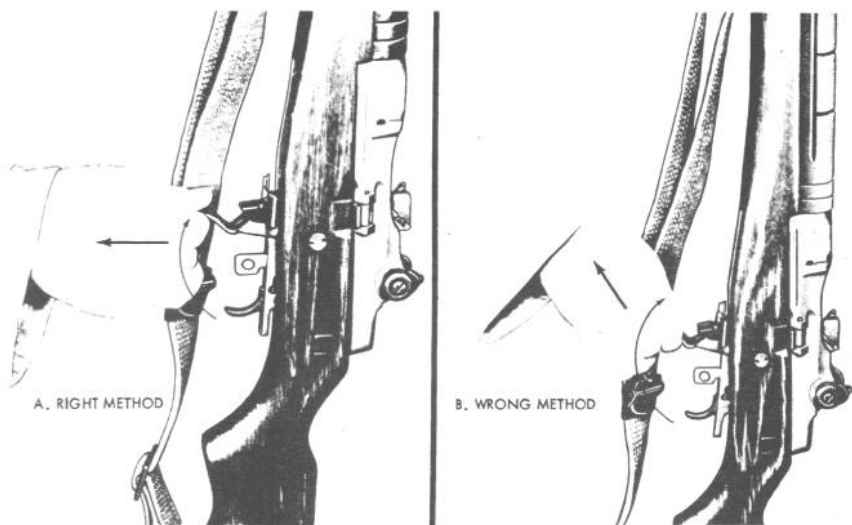

Figure 6. Removing firing mechanism.

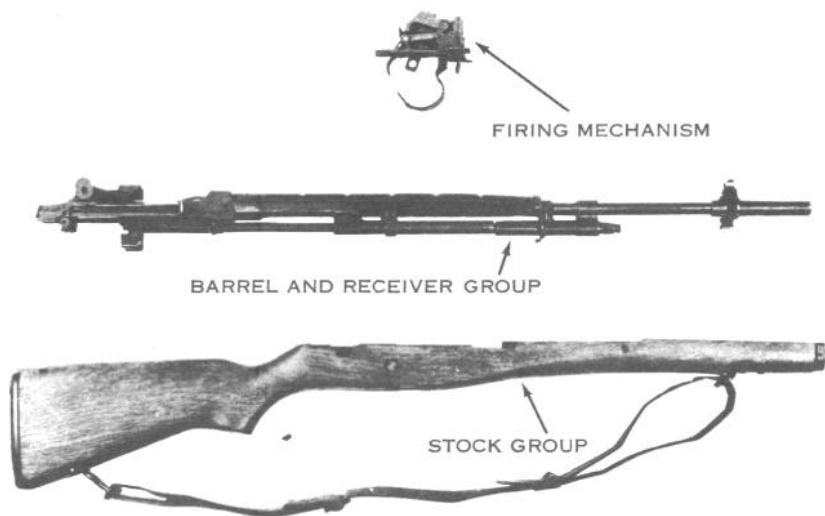

Figure 7. The three main groups.

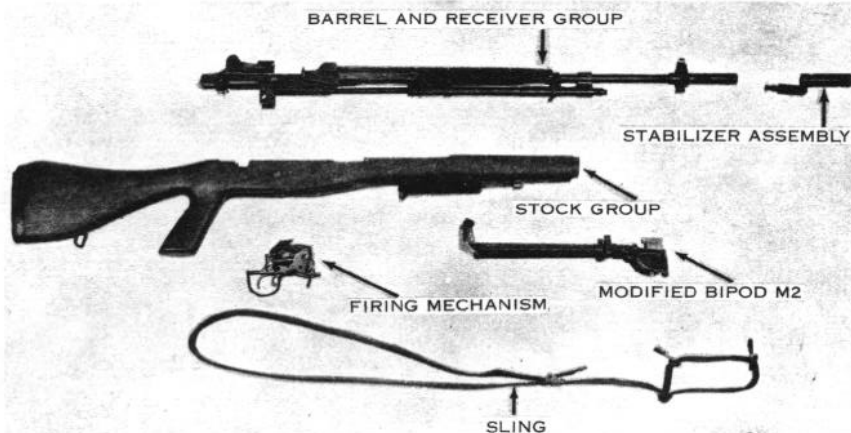

Figure 8. Components of the M14E2 rifle.

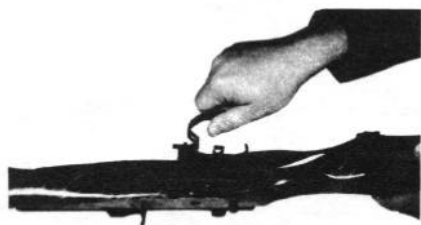

Figure 9. Replacing the firing mechanism.

9. Disassembly of the Barrel and Receiver Group

a. Removing the Connector Assembly. Place the barrel and receiver group on its left side with the operating rod handle up and the muzzle away from you. On rifles modified for selective firing, press in and turn the selector until the face marked "A" is toward the windage knob (fig. 10). With the bolt closed, place the right thumb on the rear of the connector assembly, the first finger on the sear release bracket and the second finger inside the rear of the receiver (fig. 11). Push forward with the thumb until the forward end of the assembly can be lifted off the connector lock with the thumb and forefinger of the left hand (2, fig. 11). (Note that the rifle shown in 1, 2, and 3, fig. 11 has not been modified for selective firing.) Turn the con-

connector assembly (3, fig. 11) clockwise until the elongated hole in the connector assembly is aligned with the elongated stud on the sear release. Lower the front end of the connector assembly and lift the rear end off the elongated stud of the sear release.

b. Removing the Operating Rod Spring and Operating Rod Spring Guide. Place the barrel and receiver group on a flat surface, sights down, muzzle to the left. With your left hand, pull toward the muzzle on the operating rod spring to relieve pressure on the connector lock (1, fig. 12). With your right forefinger, pull the connector lock toward you and, allowing the operating rod spring to expand slowly, disconnect and remove the operating rod spring and operating rod spring guide (2, fig. 12). Separate these two parts.

c. Removing the Operating Rod. Turn the barrel and receiver group so the sights are up and the muzzle is pointing away from you. Pull back the operating rod handle until the guide lug on its inside surface is aligned with the disassembly notch on the right side of the receiver. Rotate the operating rod downward and outward, then pull it to the rear, disengaging it from the operating rod guide (fig. 13).

d. Removing the Bolt. Grasp the bolt by the roller and, while sliding it forward, lift it upward and outward to the right front with a slight rotating motion (fig. 14).

e. *Rifle Field Stripped.* The parts of the barrel and receiver group in their order of disassembly are shown in figure 15.

10. Assembly of the Barrel and Receiver Group

a. *Replacing the Bolt.* Place the barrel and receiver on the table, sights up, muzzle pointing

away from you. Hold the bolt by the roller and locking lug and place the rear of the bolt on the bridge of the receiver, firing pin tang pointed down. Turn the bolt slightly counterclockwise until the tang of the firing pin clears the bridge. Guide the left locking lug of the bolt into its groove on the left side of the receiver. Lower the right locking lug on its bearing surface and slide the bolt halfway to the rear.



Figure 10. Position of the selector for removing the connector assembly (rifle modified for selective firing).



Figure 11. Removing the connector assembly.

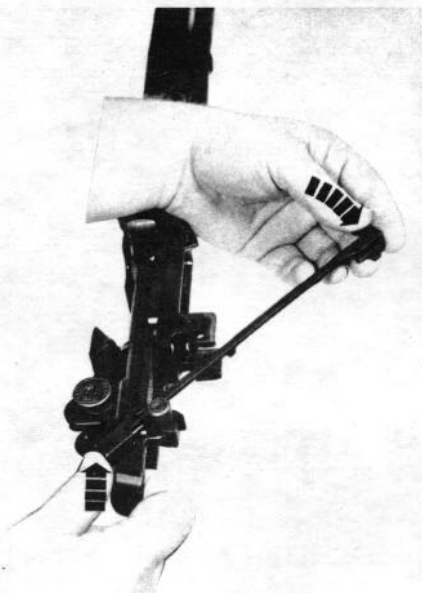

Figure 11—Continued.



Figure 11—Continued.

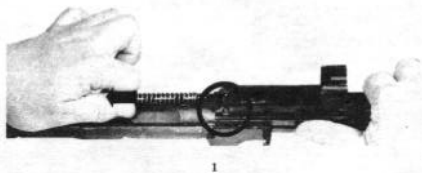

Figure 12. Removing the operating rod spring and operating rod spring guide.



Figure 12—Continued.



Figure 13. Removing operating rod.

b. Replacing the Operating Rod. Holding the operating rod at the handle, place the front end into the operating rod guide, and position the rod so that the recess in the hump fits over the bolt roller. Turn the operating rod to the left until the guide lug fits into the disassembly notch on the receiver, then move the operating rod forward until the bolt is closed.

c. Replacing the Operating Rod Spring and Operating Rod Spring Guide. Turn the barrel and receiver over so the sights are down and the muzzle is to the left. Place the operating rod spring guide into the operating rod spring, hump up, and feed the loose end of the spring into the operating rod. Grasp the spring and guide with the left hand and compress the spring until the



Figure 14. Removing the bolt.

hole in the guide can be aligned with the connector lock. Lower the guide and push the connector lock in with the right thumb (fig. 16).

d. Replacing the Connector Assembly. Place the barrel and receiver on its side with the operating rod handle up, muzzle away from you. Place the elongated hole in the rear of the connector assembly on the elongated stud on the sear release (1, fig. 17). Place the thumb of the right hand on the rear of the connector assembly, the first finger on the sear release bracket, and the second finger inside the rear of the receiver. Pushing toward the muzzle with the right thumb and with the thumb and first finger of the left hand, turn the front of the connector counterclockwise until it can be snapped onto the connector lock (2, fig. 17).

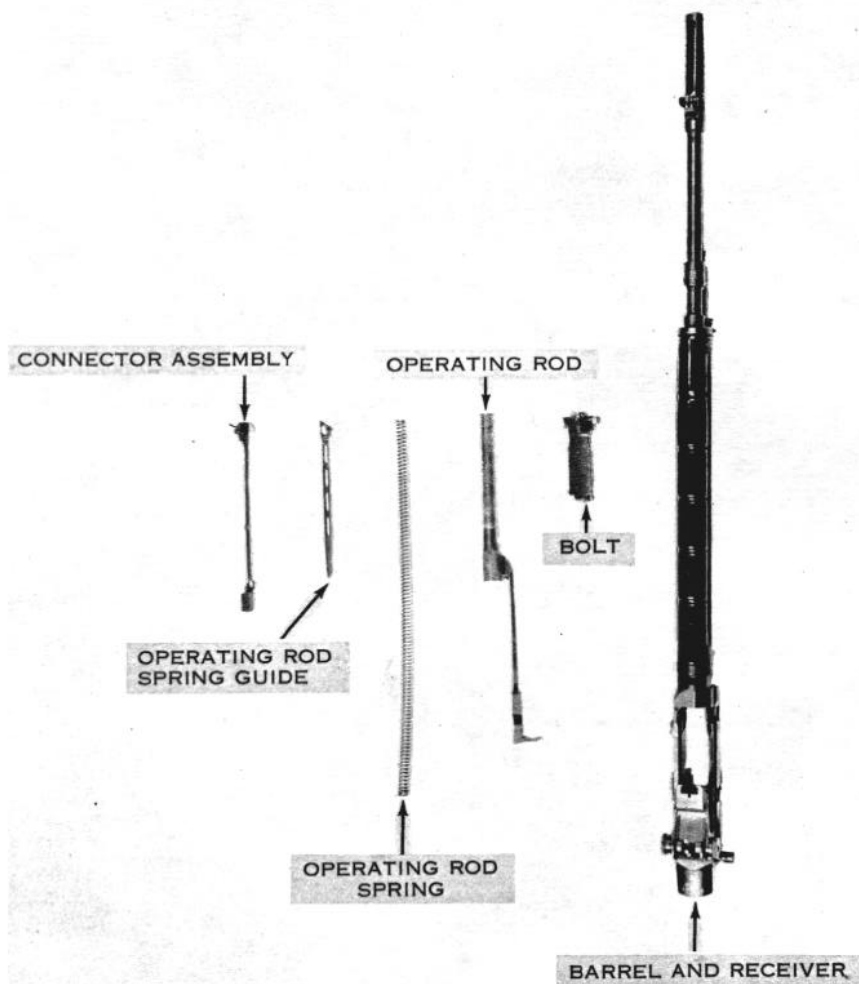

Figure 15. Parts of the barrel and receiver group in the order of disassembly.

11. Disassembly of the Gas System and Handguard

(fig. 18)

Note. Under normal usage the gas cylinder should not be disassembled as long as the gas piston slides freely within the cylinder when the barrel is tilted end-for-end from an upright position (bolt should be locked to the rear). Disassembly of the gas cylinder is sometimes necessary after the weapon has been subjected to extreme climatic conditions.

a. Gas System. Using the wrench of the combination tool, loosen and remove the gas cylinder plug. Tilt the muzzle down and remove the gas piston from the gas cylinder. Unscrew the gas cylinder lock and slide the lock and cylinder forward so that the gas port is exposed.

b. Handguard. Slip the front band forward toward the front sight. Push the handguard toward the front sight and lift it from the barrel.

12. Assembly of the Gas System and Handguard

a. Handguard. Place the rifle on a flat surface, sights up and muzzle to the right. Engage the ends of the band on the handguard with the front (muzzle) end of the slots that are on the rear of the barrel and slide the handguard rearward. (Do not snap or force the handguard into its installed position.) Replace the front band.

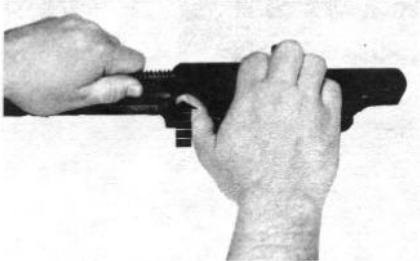

Figure 16. Replacing the operating rod spring and operating rod spring guide.



1
Figure 17. Replacing the connector assembly.



2
Figure 17—Continued.

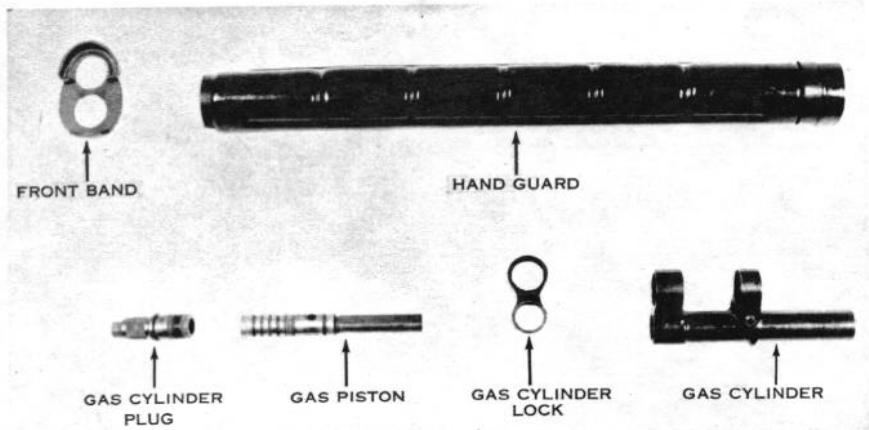

Figure 18. Parts of the gas system; handguard and front band.

b. Gas System. Slide the gas cylinder rearward through the front band. Tighten the gas cylinder lock by hand to its fully assembled position, then back it off until the loop is aligned with the gas cylinder. Replace the gas piston with the flat part toward the barrel and the open end toward the muzzle. When the gas piston is properly seated, it will protrude one and one-half inches below the gas cylinder (fig. 19). Replace the gas cylinder plug and tighten it securely with the wrench of the combination tool.

13. Removing the Stabilizer Assembly of the M14E2 Rifle

To remove the stabilizer assembly, use the wrench end of the combination tool to loosen the locknut. Then slide the combination tool over the screw and loosen it. Swing the yoke away from the bayonet lug, and slide the stabilizer assembly off the flash suppressor (fig. 20).

14. Replacing the Stabilizer Assembly of the M14E2 Rifle

To replace the stabilizer assembly slide it over the flash suppressor, swing the yoke over the bayonet lug, and tighten the screw with the combina-

tion tool (fig. 21). Slide the combination tool over the head of the screw and place it over the locknut.

15. Disassembly of the Magazine

a. Use a pointed object to raise the rear of the magazine base (fig. 22) until the indentation on the base is clear of the magazine. Grasp the magazine with either hand, with one finger of the hand covering the base. Remove the base and guide the spring, one coil at a time, to clear the retaining lips of the magazine.

b. Remove and separate the magazine spring and follower. Figure 23 shows the parts of the magazine.

16. Assembly of the Magazine

Reposition the spring inside the follower with the rectangular-shaped end of the spring against the rear of the follower, and replace the follower and spring inside the magazine. Be sure to fully seat the follower. Replace the magazine base (fig. 24).

Note. The bolt, rear sight, and the firing mechanism will not be disassembled by the individual under any circumstances (chart I).

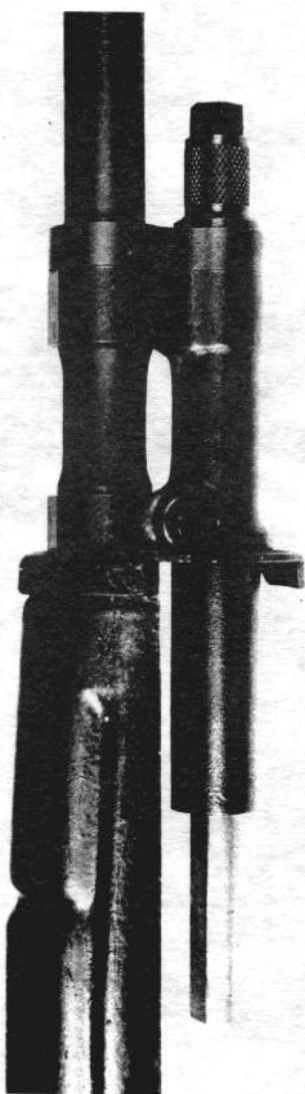

Figure 19. Gas piston properly seated.

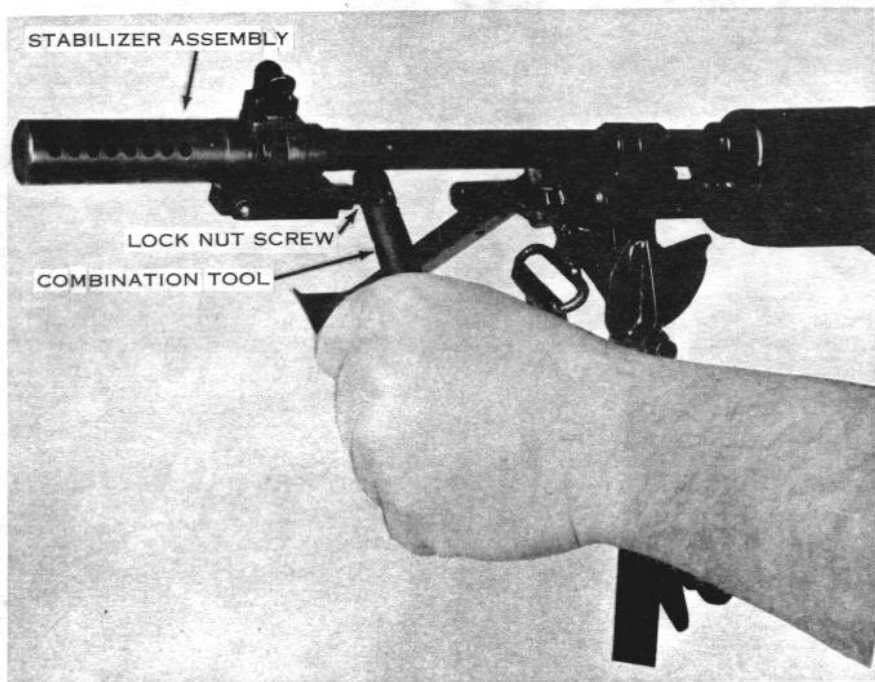

Figure 20. Removing the stabilizer assembly.

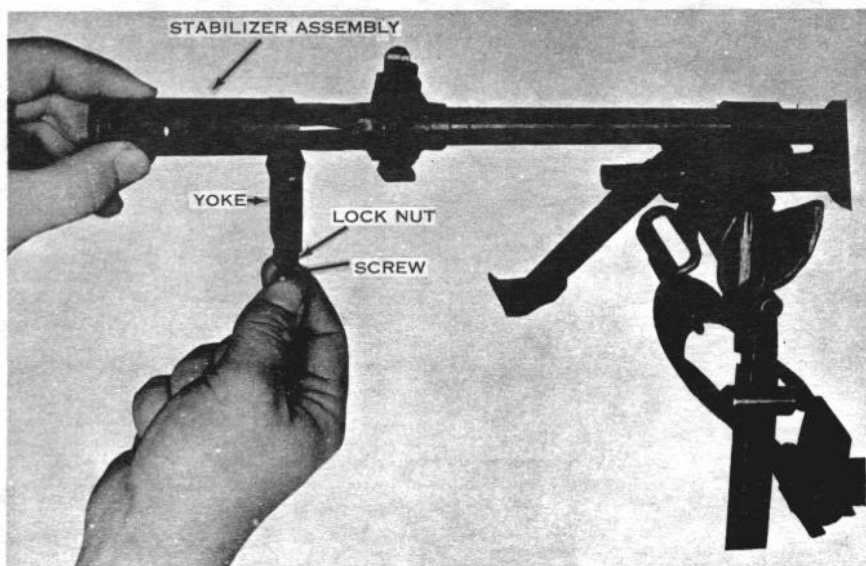

Figure 21. Replacing the stabilizer assembly.

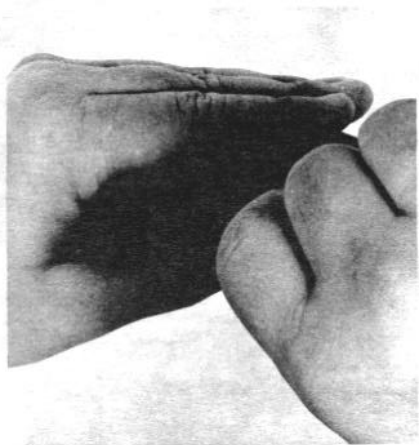

Figure 22. Removing the base of the magazine.

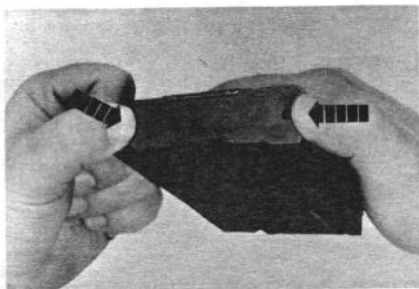

Figure 24. Replacing the magazine base.

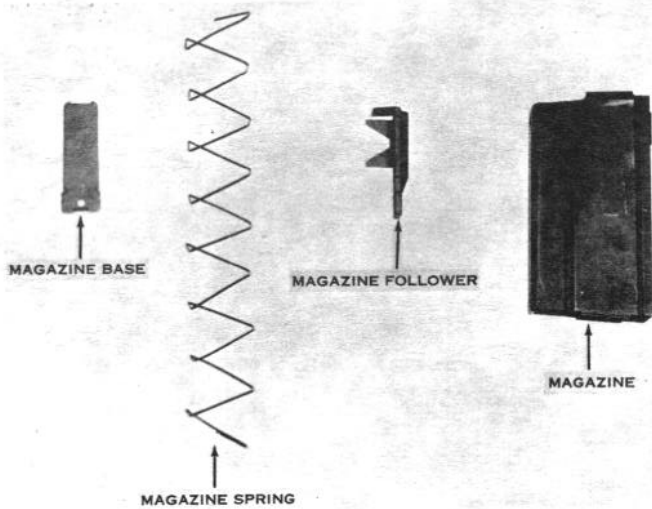

Figure 23. Parts of the magazine.

CHAPTER 3

OPERATION AND FUNCTIONING

Section I. OPERATION

17. Loading the Magazine (Out of the Rifle)

a. Place each round on top of the magazine follower (with the bullet end toward the front of the magazine) and apply pressure with the thumb to fully seat the round in the magazine (fig. 25).

b. To load the magazine with a 5-round cartridge clip, the magazine filler is used (fig. 26). Slide the filler over the top rear portion of the magazine and insert a 5-round cartridge clip into the filler. Place either the thumb or the open end of the combination tool on the top round and push the 5 rounds into the magazine. Remove the clip and repeat the process until 20 rounds have been loaded into the magazine, then remove the magazine filler.

18. Loading the Magazine (in the Rifle)

a. To load a single round into an empty magazine in the weapon, lock the bolt to the rear and engage the safety. Place a round on top of the magazine follower and press down on the round and fully seat it in the magazine (fig. 27).

b. A magazine in the weapon can be loaded through the top of the receiver with a 5-round cartridge clip. To do this, place either end of the clip in the cartridge guide, then exert pressure with the thumb or the open end of the combination tool on the top round, forcing 5 rounds into the magazine (fig. 28). Remove and discard the cartridge clip. Repeat the process until the magazine is loaded.

19. Loading and Unloading the Rifle

a. Place the safety in the safe position.

b. Insert a loaded magazine into the magazine well, top front first, until the operating rod spring guide engages the magazine (1, fig. 29), then pull backward and upward until the magazine snaps into position (2, fig. 29). A click will be heard which indicates that the magazine is fully seated. Pull back and release the operating rod handle, allowing the bolt to strip the top round from the magazine and load it into the chamber.

c. Remove the magazine as described in paragraph 6.

Section II. FUNCTIONING

20. Semiautomatic

a. Each time a round is fired, the parts inside the rifle work together in a given order. *This is the cycle of operation.* This cycle is similar in all

small arms. A knowledge of what happens inside the rifle during the cycle of operation will help you to understand the causes of, and remedies for, various stoppages.

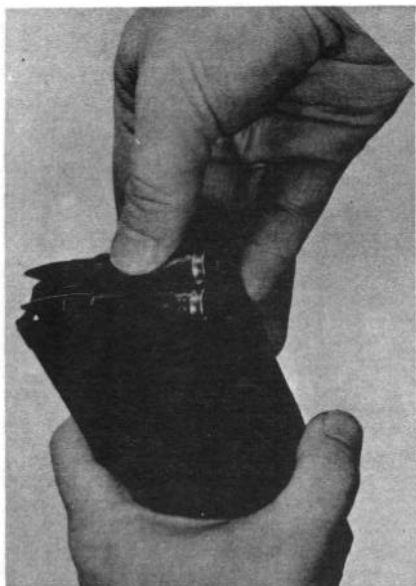

Figure 25. Loading the magazine single round (out of rifle).



Figure 27. Loading the magazine with a single round (magazine in rifle).

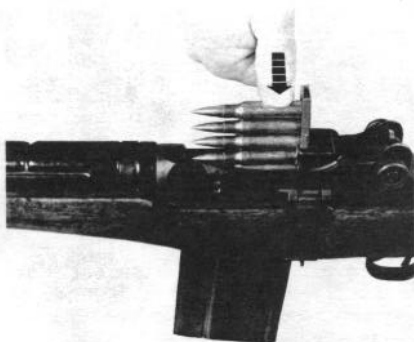

Figure 28. Loading the magazine with a 5-round cartridge clip (magazine in rifle).



Figure 26. Loading the magazine using the magazine filler (magazine out of rifle).



Figure 29. Loading the magazine into the rifle.



2
Figure 29—Continued.

b. The cycle of operation is broken down into eight steps. These steps are listed below, together with a brief description of what occurs inside the rifle during each step.

- (1) *Feeding.* Feeding takes place when a round is forced into the path of the bolt. The top round is forced into the path of the bolt by the magazine follower which is under pressure of the magazine spring (fig. 30).
- (2) *Chambering.* Chambering occurs when a round is moved into the chamber. This takes place as the bolt goes forward under pressure of the expanding operating rod spring, stripping the top round from the magazine and driving it forward into the chamber (fig. 31). Chambering is complete when the extractor snaps into the extracting groove on the cartridge and the ejector is forced into the face of the bolt.
- (3) *Locking.* Locking begins as the bolt roller engages the camming surface in the hump of the operating rod. It is completed when the locking lugs of the bolt are fully seated in the locking recesses of the receiver (fig. 32).
- (4) *Firing.* Firing occurs when the firing pin strikes the primer. As the trigger is pulled, the trigger lugs are disengaged from the hammer hooks and the hammer is released. The hammer moves forward

under pressure of the hammer spring and strikes the tang of the firing pin, driving the firing pin against the primer, and firing the round (fig. 33).

- (5) *Unlocking.* Unlocking (fig. 34) occurs after the firing of the round. As the bullet is forced through the barrel by the expanding gases, a small amount of gas enters the hollow gas piston, the gas cylinder, and the gas cylinder plug through the gas port. The expanding gases force the gas cylinder piston to the rear. It in turn drives the operating rod and bolt rearward. The operating rod cams the bolt roller upward, disengaging the locking lugs on the bolt from the locking recesses in the receiver. At this time the bolt is unlocked.

Note. The spindle valve must remain in the open position (the slot in the spindle head perpendicular to the barrel) during all firing, except when launching a grenade (fig. 35).

- (6) *Extracting.* Extracting is pulling the empty cartridge from the chamber. Slow initial extraction takes place as the bolt unlocks. The bolt in its rearward motion pulls the empty cartridge with it (fig. 36).
- (7) *Ejecting.* Ejecting is removing the empty cartridge from the receiver. As soon as the bolt has withdrawn the empty cartridge case clear of the chamber, the force of the ejector spring and plunger pushes the bottom edge of the cartridge base away from the bolt face, throwing it out and away from the receiver. When the last round has been fired, the bolt is held in the rearward position by the bolt lock.
- (8) *Cocking.* Cocking is positioning the hammer so that it is ready to fire the next round. The bolt, as it moves to the rear, forces the hammer down and rides over it. The hammer is caught by the sear if the trigger is held to the rear and by the trigger lugs if the trigger has been released (fig. 37). In either case, the hammer is held in the cocked position.

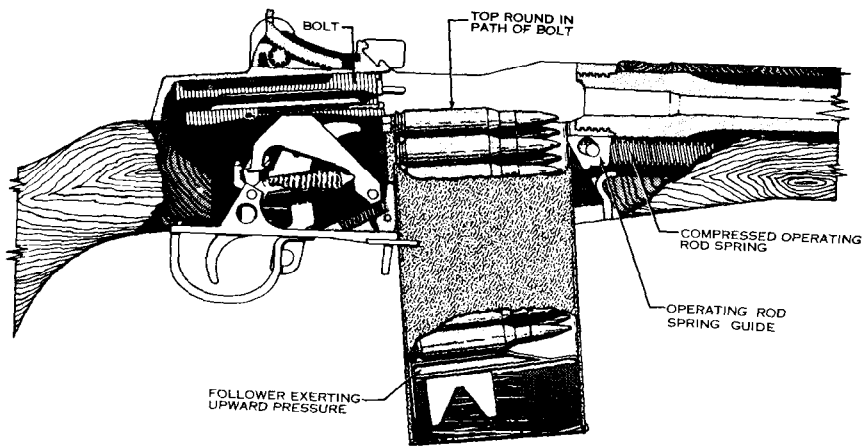

Figure 30. Feeding.

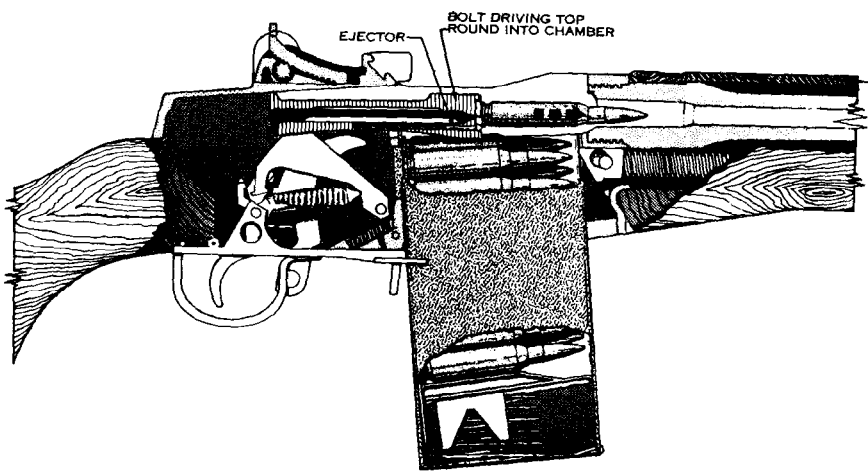

Figure 31. Chambering.

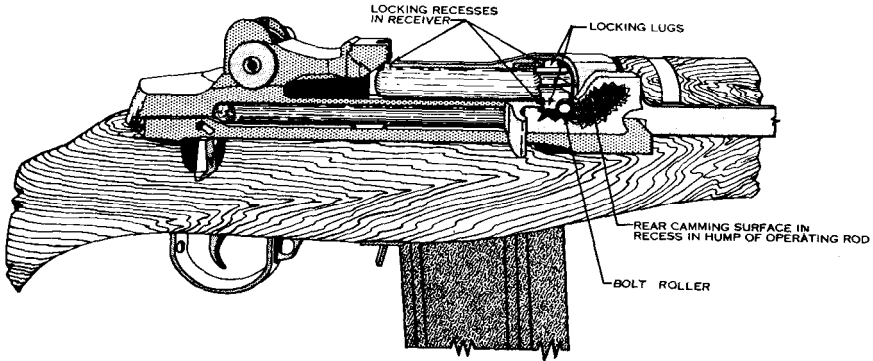

Figure 32. Locking.

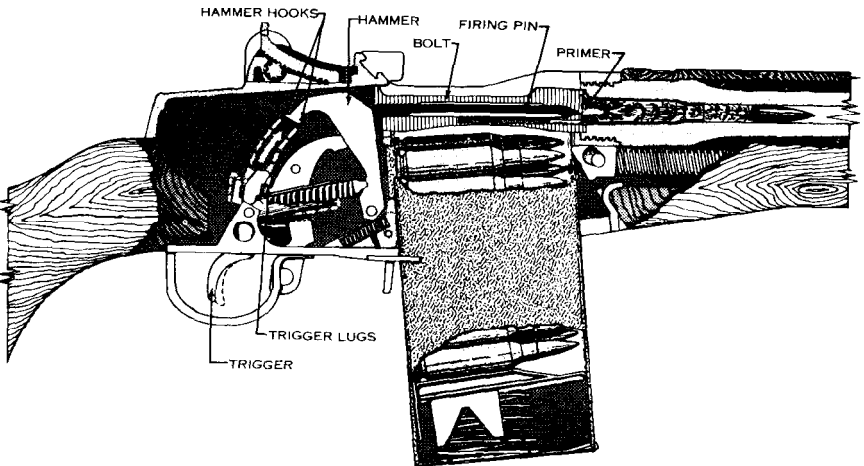

Figure 33. Firing.

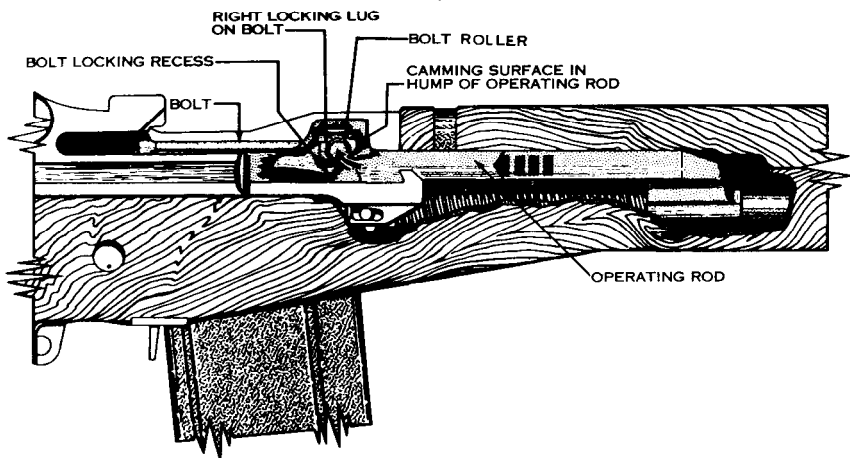
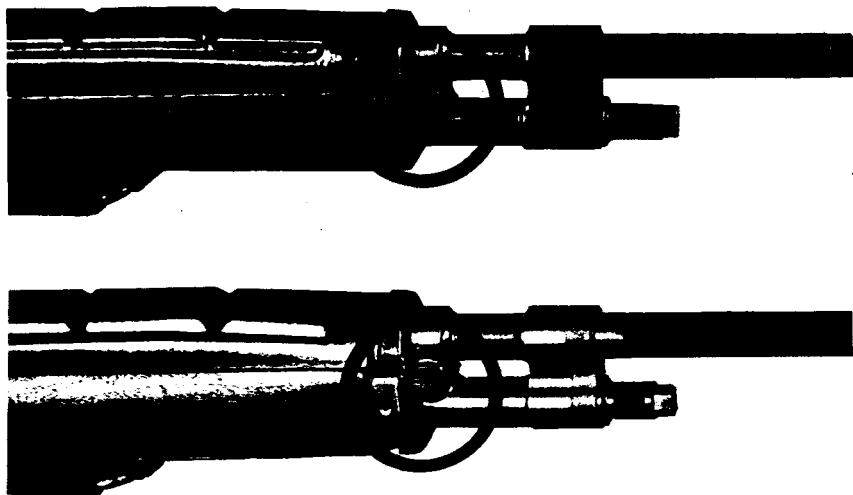

Figure 34. Unlocking.



TOP: STANDARD AMMUNITION. SEMIAUTOMATIC AND
AUTOMATIC FIRE.
BOTTOM: FOR FIRING GRENADES

Figure 35. Positions of the spindle valve.

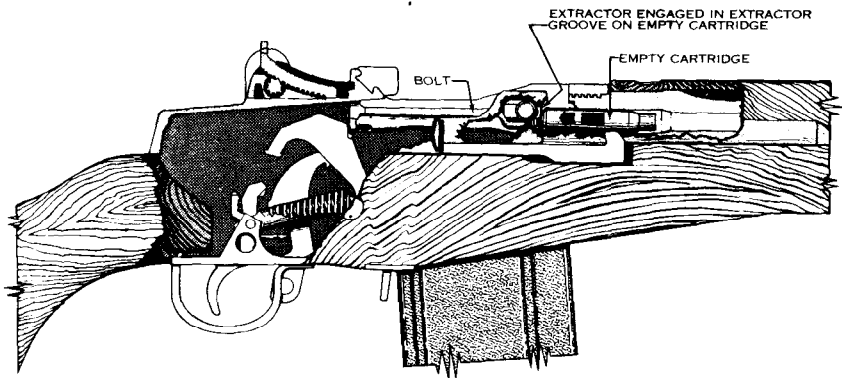

Figure 36. Extracting.

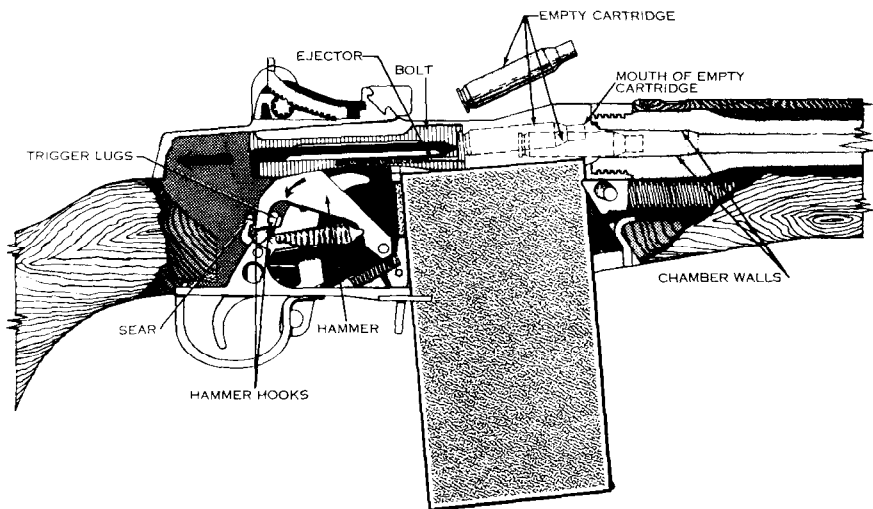

Figure 37. Ejecting the last round and cocking.

21. Automatic (Rifles Equipped With Selector)

a. When the selector is positioned with the face marked "A" to the rear (ear type projection up), the rifle is set for automatic fire. Turning the selector to automatic rotates the sear release in position to make contact with the sear.

b. After the first round has been fired (and with the trigger held to the rear), the operating rod starts its rearward movement under pressure of the expanding gases. As it moves to the rear, the connector assembly moves rearward under pressure of the connector assembly spring. The movement of the connector assembly rotates the sear release on the selector shaft so that the flange on

the sear release allows the sear to move forward into a position where it can engage the rear hammer hooks (1, fig. 38). Then, when the bolt drives the hammer to the rear, the sear engages the rear hammer hooks and holds the hammer in the cocked position.

c. After the bolt moves forward and locks, the shoulder on the operating rod engages the hook of the connector assembly and forces it forward. This rotates the sear release on the selector shaft, causing the flange on the sear release to push the sear to the rear, disengaging it from the rear hammer hooks (2, fig. 38). The hammer will then go forward if the trigger is held to the rear. If the trigger is released at any time prior to the firing of the last round, the hammer will be held in the cocked position by the trigger lugs.

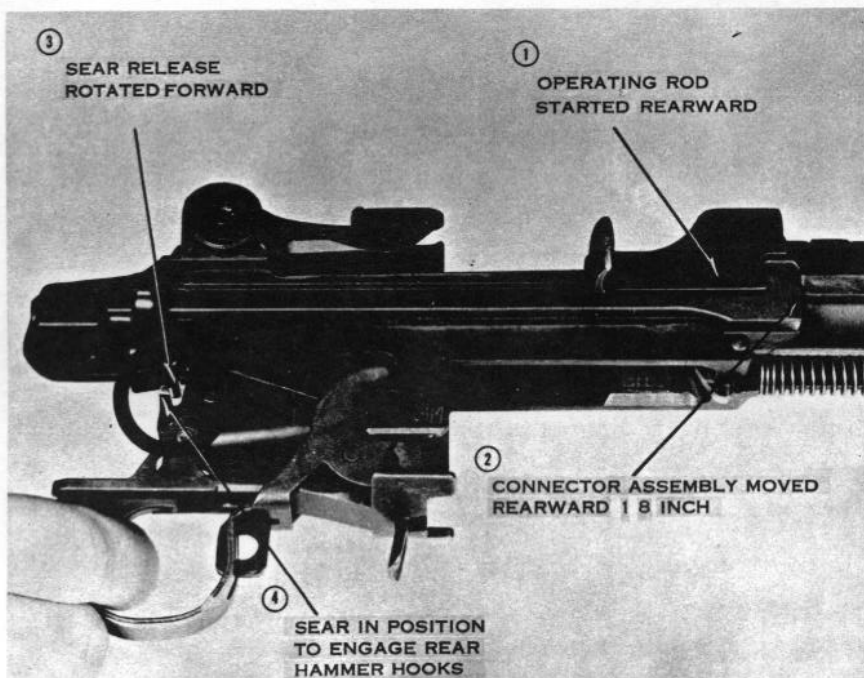

1

Figure 38. Actions of the connector assembly and its effects on the firing mechanism during automatic firing.

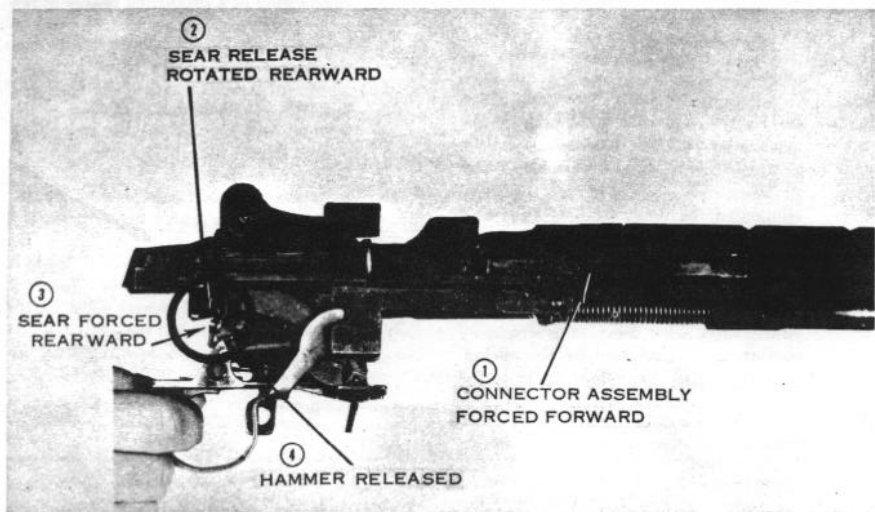

2
Figure 38—Continued.